

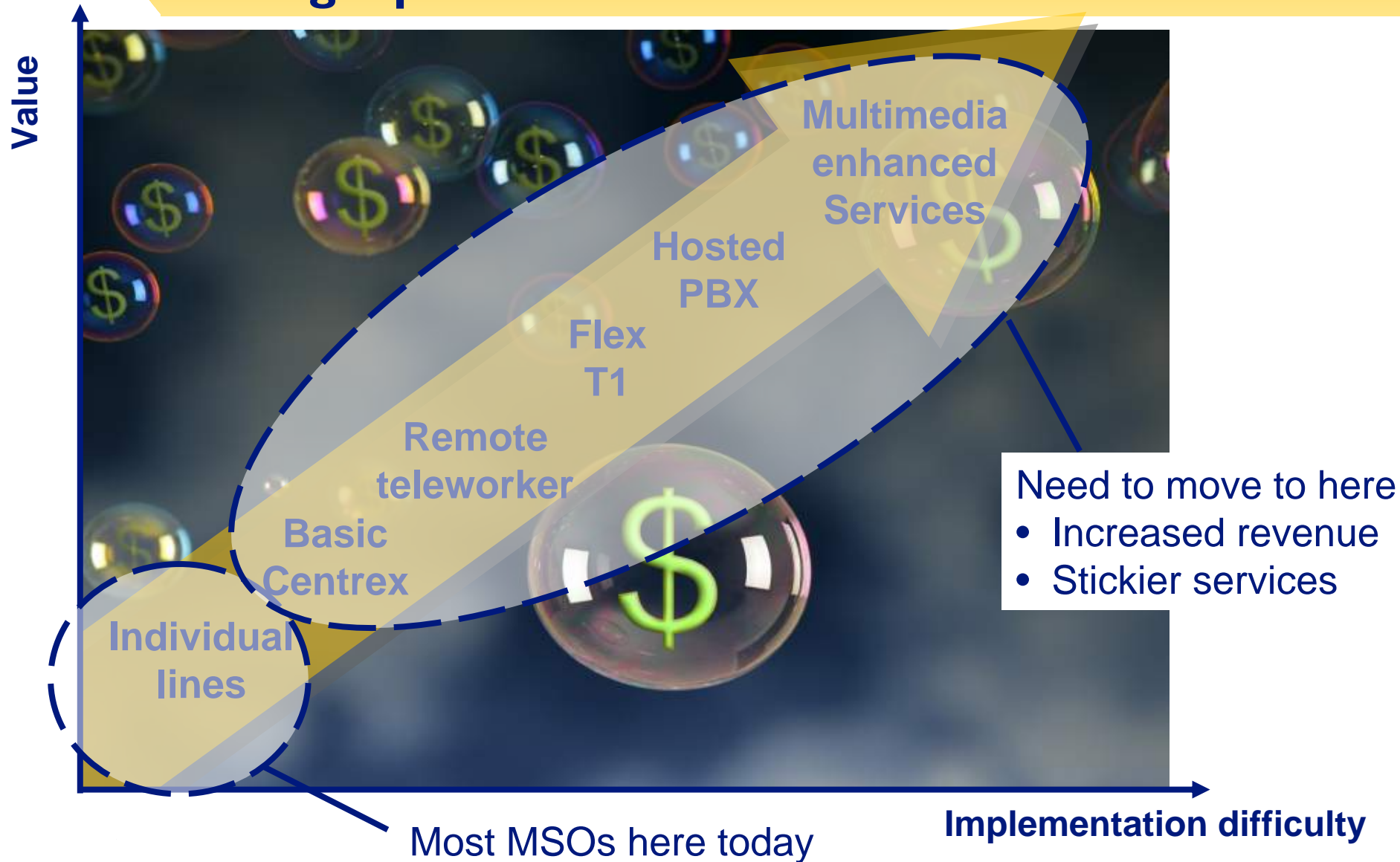

# **MSO Business Voice Services**

**Andy Randall**  
**Vice President, Marketing – MetaSwitch**

## Moving Up the Value Chain







## A Dose of Reality: The SMB Needs Hierarchy



SMBs do **not** want

- “VoIP”
- “digital voice”
- “voice over cable”

## Basic Small Business Centrex

-  Same network topology as residential VoIP (analog phones, NCS signaling, eMTA, etc.)
-  Centrex dial plan enables 3/4 digit dialing, pickup groups, multiple appearance directory number, etc.
-  Basic set of group services
-  Most (but not all) softswitches can deliver this level of business features

### Service Package

- Short-code dialing
- Voicemail
- Call transfer / conference
- Call forwarding
- Call hold
- Call waiting
- Call pickup groups (\*11)
- Caller ID/name, single outgoing number
- Multiple appearance directory number
- (Unlimited LD option)

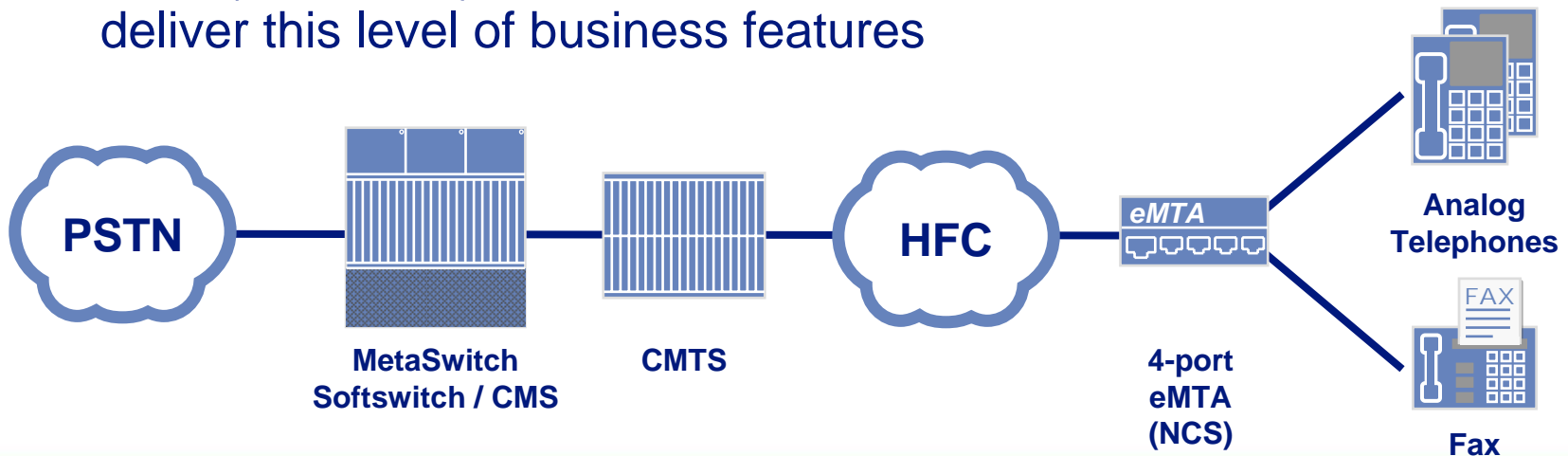

## Remote Worker / Road Warrior Support

- ✈ Deliver VoIP via remote worker's existing broadband connection
  - Home: MTA or IP phone via DSL/cable
  - On the road: softphone via hotel broadband
- ✈ Integrated with main office dial plan
- ✈ Session Border Controller (SBC) for NAT traversal, security
- ✈ Nomadic 911 support required

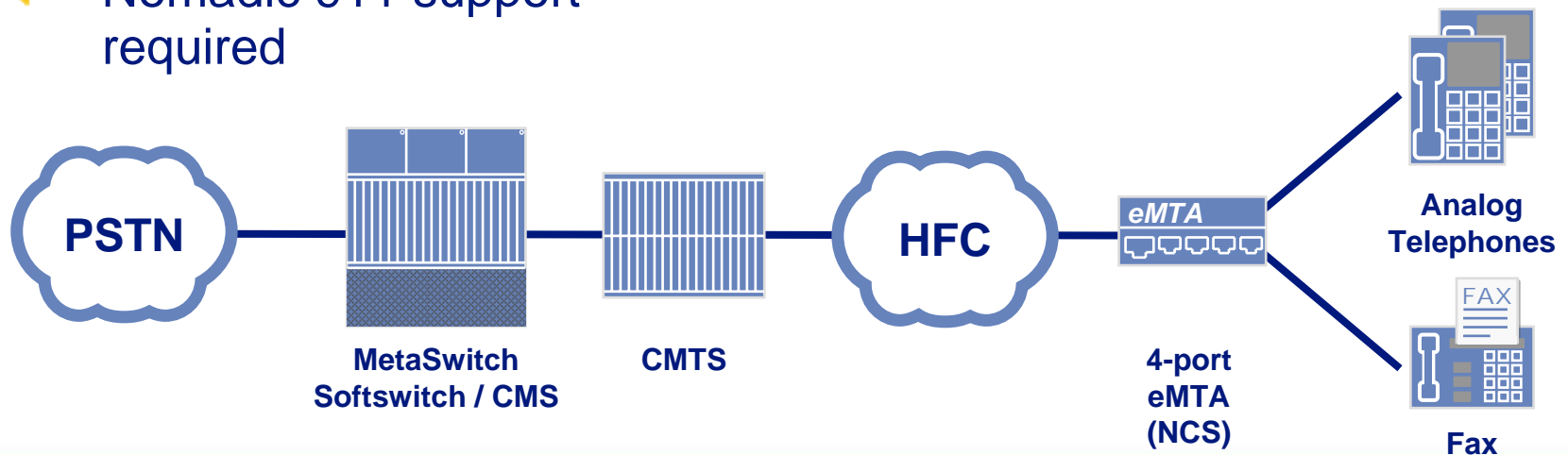

## Remote Worker / Road Warrior Support

- ✈ Deliver VoIP via remote worker's existing broadband connection
  - Home: MTA or IP phone via DSL/cable
  - On the road: softphone via hotel broadband
- ✈ Integrated with main office dial plan
- ✈ Session Border Controller (SBC) for NAT traversal, security
- ✈ Nomadic 911 support required

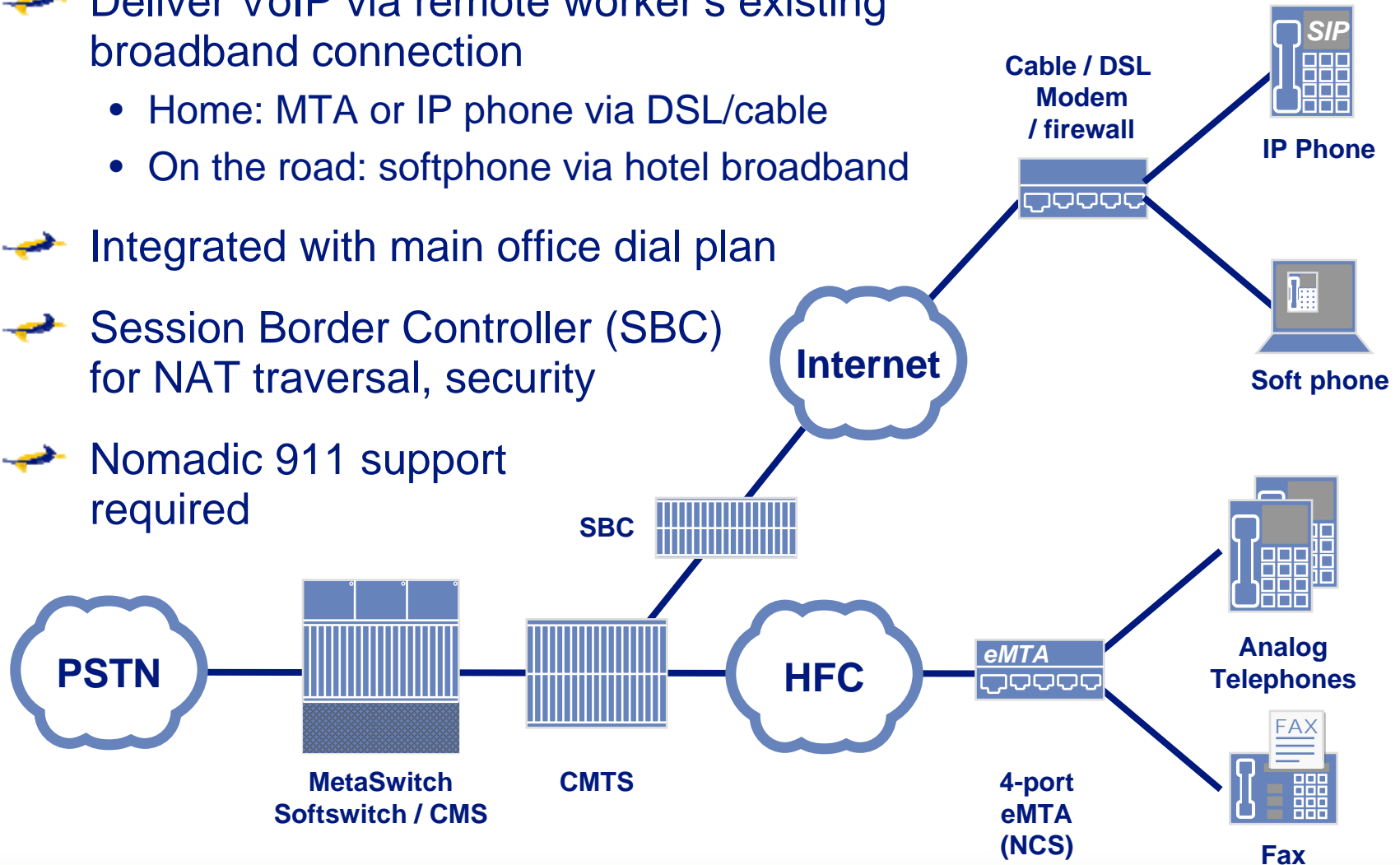

## Packet-based “Integrated T1” Service

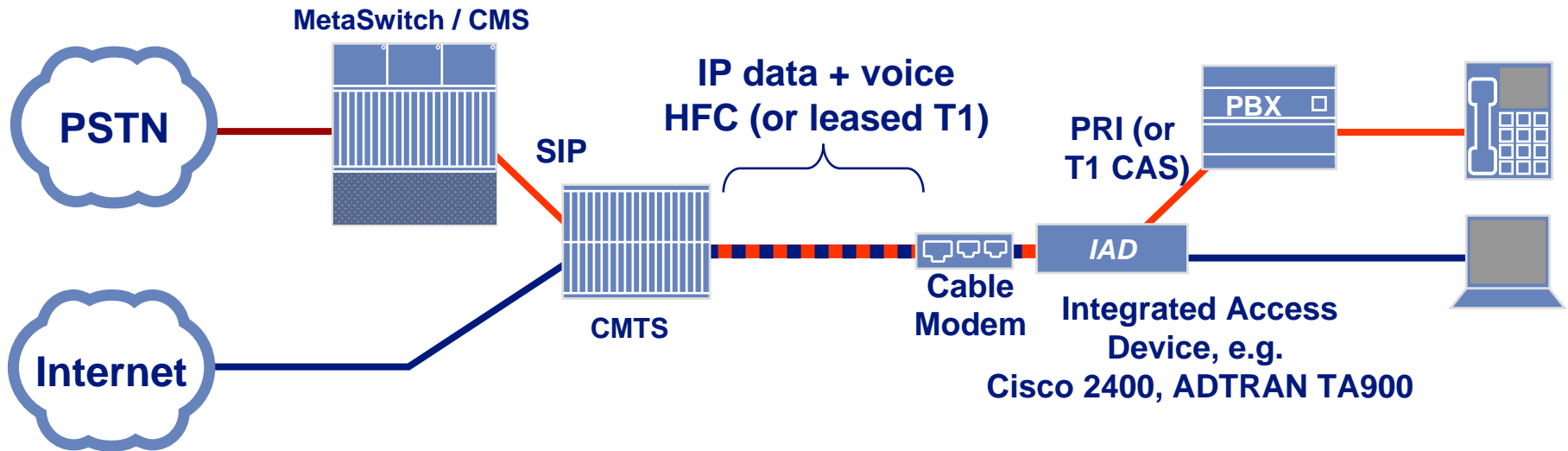

- ✈ The most widely deployed business VoIP service today
  - Easy to sell - No change to customer phone system
  - Combine with / migrate over time to hosted service
- ✈ IAD converts PRI to SIP (much more reliable than early TDM encapsulation approaches)
  - Some PBXs now support native SIP – removes IAD cost
- ✈ Simulated facility groups limit max number of lines in use

# Small / Medium Business “Hosted PBX” Service

## Service Package

### Basic Centrex service plus:

- Unified messaging (hosted voicemail / fax / email)
- Auto attendant with dial-by-name directory
- Call park / retrieve
- Directed pickup
- Line state monitoring
- Intercom
- ACD
- Account codes (mandatory / optional / group / personal)
- Music on hold (configurable)
- Meet-me conferencing

- ✈ Higher revenue, higher margin service
  - Reduced churn (customer tied much more closely to service provider)
  - Often bundled with full network management
- ✈ Few softswitches can deliver this capability – 3rd party feature server adds complexity
  - MetaSwitch builds it into a single, coherent switching and applications platform
- ✈ Combine with legacy analog and digital phones (e.g. p-phone) via Citel gateway

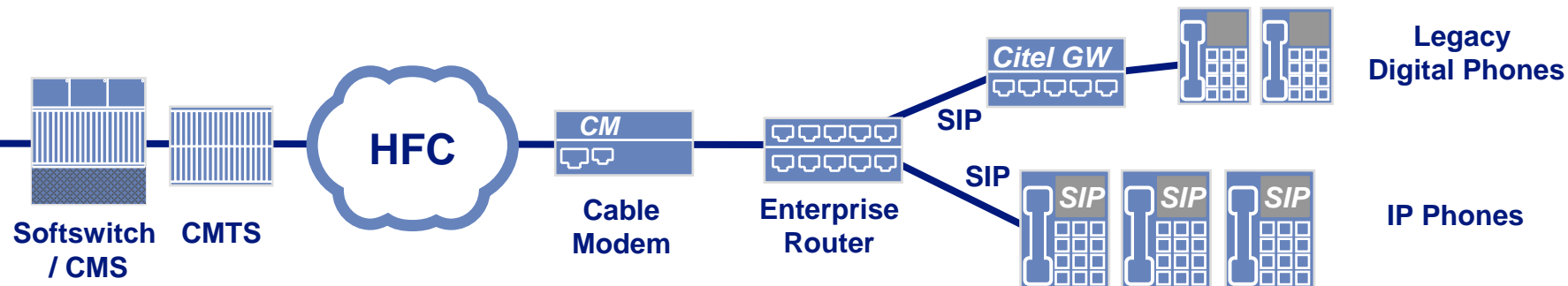

## Wide Choice of SIP Business Phones

- ✈ SIP phones finally getting rich feature equivalence with proprietary handsets
- ✈ But...
  - Flexibility can be a double-edged sword
  - Many implementations still rapidly evolving



# Multimedia-Enhanced Telephony Services

## Web Self-Care

- Individual line settings
- Integrated visual voicemail
- Call logs
- Business group administration
- Find-me / follow-me
- Time-of-day call treatment

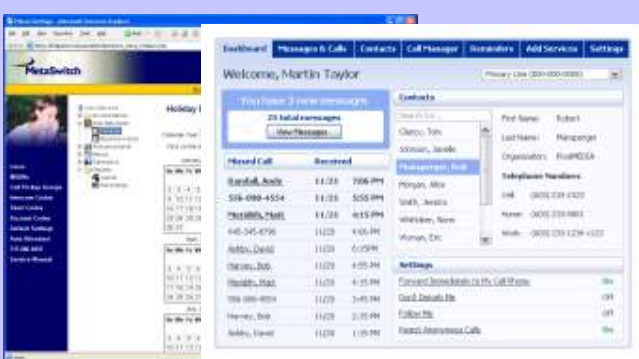

## Soft Attendant Console

- Advanced call control for power users, receptionists
- Busy lamp fields
- Calendar integration
- Call stack
- Real-time call control



## Fixed/Mobile Convergence

- One Number service
- Integrated mailbox
- Fixed-to-cell handoff



## Desktop Assistant

- Outlook integration
- Presence / IM
- Click-to-dial
- Incoming call popup
- Missed calls indicator
- Brandable HTML message area



## Conclusion

- **Plenty of opportunity for MSOs to move into business services**
- **No “one size fits all” service**
  - **Market segmentation should lead technology choices**
- **MetaSwitch has deployed all these solutions (and more) with more than 200 North American cable operators and telcos**

